



OWNER'S MANUAL

LG Digital Signage

(MONITOR SIGNAGE)

Please read the user manual before using this product to ensure safe and convenient use.

55TR3DQ-B 55TR3DQ-I

65TR3DQ-B 65TR3DQ-I

75TR3DQ-B 75TR3DQ-I

86TR3DQ-B 86TR3DQ-I

Table of Contents

Getting to Know the Product 3

Checking Components..... 3

Checking Optional Components..... 5

Installing the Product 6

Installing on Wall..... 6

Checking Wall Mount Support Specifications 6

Installing the Product 7

Connecting to Power..... 8

Exploring the Product 9

Names of Each Part..... 9

Front 9

Back 10

Side 11

Checking the Input/Output Terminals 12

Front Cable Terminal 12

Side Cable Terminal 13

Bottom Cable Terminal 14

Using the Touch Pen 15

Getting to Know the Touch Pen Functions 15

Storing the Pen 16

Replacing the Pen Tip 16

Using the Wi-Fi Module 17

Installation Procedure 17

Feature 17

Precautions for Use 18

Dust..... 18

Afterimage 18

Recommended Usage Condition 19

Product Specifications 20

Touch screen..... 21

Speaker 21

Specifications by Model 22

Resolution..... 23

Wireless module Specifications..... 25

Licence 26

WARNING - This equipment is compliant with Class A of CISPR 32. In a residential environment this equipment may cause radio interference.

Getting to Know the Product

Checking Components

An electronic blackboard is a display product that can be used by touching the screen. A touch pen, remote control and others are provided with the product. If any of the listed components are missing, contact customer support. LG Electronics also sells optional components that can help you use the product more effectively as separate purchases.

Product specifications or components may change without prior notice according to the quality improvements or feature upgrades.



Caution

- To ensure user safety and product longevity, do not use counterfeit products. If the product is damaged as a result of using counterfeits, the warranty does not apply. In such cases, the user cannot be compensated even if injured.
- If the product is used in an environment with excessive dust, the warranty does not apply.



Note

- Remove all tapes attached to the front before connecting the product to power.
- Cables used when connecting to external devices must be purchased separately.
- Keep the product box and do not discard it. It can be used when moving the product.

Checking Components

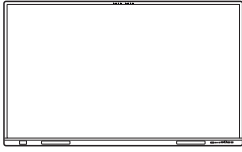

Electronic blackboard

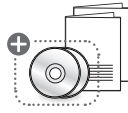

User manual and warranty

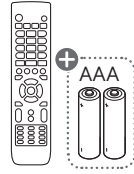

Remote control and batteries
(AAA, 2 pieces)



HDMI cable



Power cable

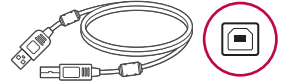

TOUCH cable



USB Type-C cable

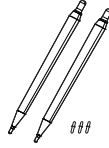

Touch pens and pen tips (2 each)



Wi-Fi Module

! Note

- ⊕ : Availability may vary depending on your geographic location.
- The components provided in the box may vary depending on the region and model.
- Component images shown in the user manual are for the user's understanding and may differ from actual components.

Checking Optional Components

Optional components may change without prior notice to improve product performance. New components may be added.

Note

- All optional components are separate purchases. Contact LG Electronics if you wish to purchase them.
- Component images shown in the user manual are for the user's understanding and may differ from actual components.

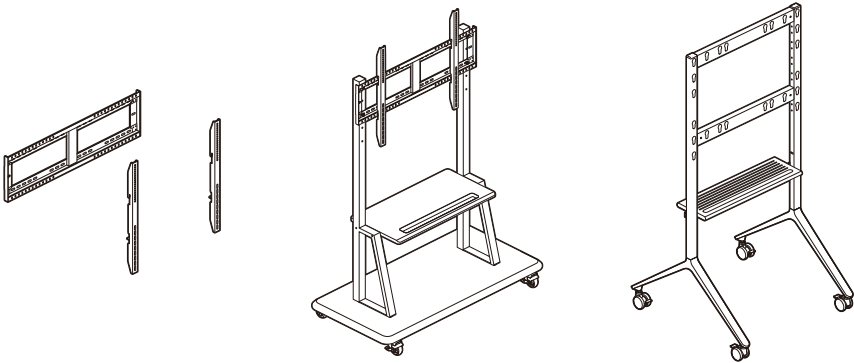

Wall Mount Holder (WM-L000S)

Floor stand (ST-000F)

Universal stand (ST-860F)

Installing the Product

Installing on Wall

The electronic blackboard can be used in a wall-mounted format by securing it to a wall. To install it on a wall, first attach a wall mount support (optional) to the back of the product body.

The wall mount support is a separate purchase and can be purchased from a nearby dealer. For more information on installing a wall mount support, see the installation guide provided with your wall mount support purchase.

Checking Wall Mount Support Specifications

When installing a wall mount support, you must use screws and brackets that comply with VESA (Video Electronics Standards Association) standard specifications.

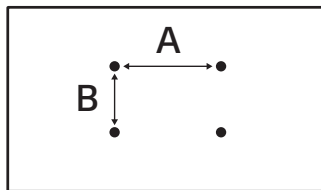

Model Name	VESA Dimensions (A x B) (mm)	Screw Specifications	Maximum Length (mm)	Quantity
	VESA Dimensions (A x B) (inches)		Maximum Length (inches)	
55TR3DQ-B	400 x 200	M8	25	4
55TR3DQ-I	15.7 x 7.8		0.9	
65TR3DQ-B	600 x 400	M8	25	4
65TR3DQ-I	23.6 x 15.7		0.9	
75TR3DQ-B	800 x 400	M8	25	4
75TR3DQ-I	31.4 x 15.7		0.9	
86TR3DQ-B	800 x 600	M8	25	4
86TR3DQ-I	31.4 x 23.6		0.9	

⚠ Caution

- Disconnect the power cord first before moving or installing the product. There is risk of electric shock.
 - Do not install the product on a ceiling or sloped wall. There is a risk of falling and injury.
 - If you tighten the screws too tightly and damage the product, the warranty may not apply.
 - Use screws and brackets for wall mounting that meet the VESA standard specifications. The warranty does not apply to the breakage or personal injury due to the use of incorrect components.
 - Using screws longer than VESA standard specifications when installing a wall mount support may damage the interior of the product.
- In such cases, we do not take responsibility for any damage or issues that may arise with the product.

Installing the Product

Allow at least 10 cm (3.9 inches) of clearance from the wall for ventilation, and install the product with care to prevent it from falling. When purchasing a wall mount support, the installation guide and all necessary parts are included. A wall mount support can be purchased separately from a nearby dealer.

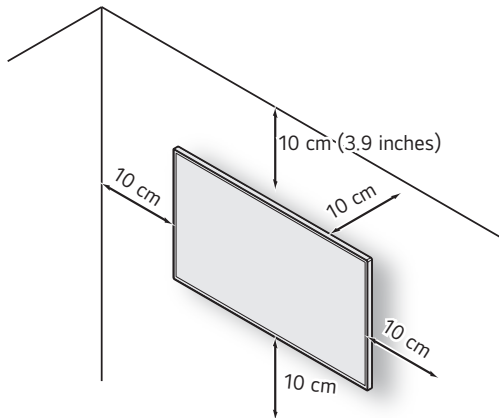

Connecting to Power

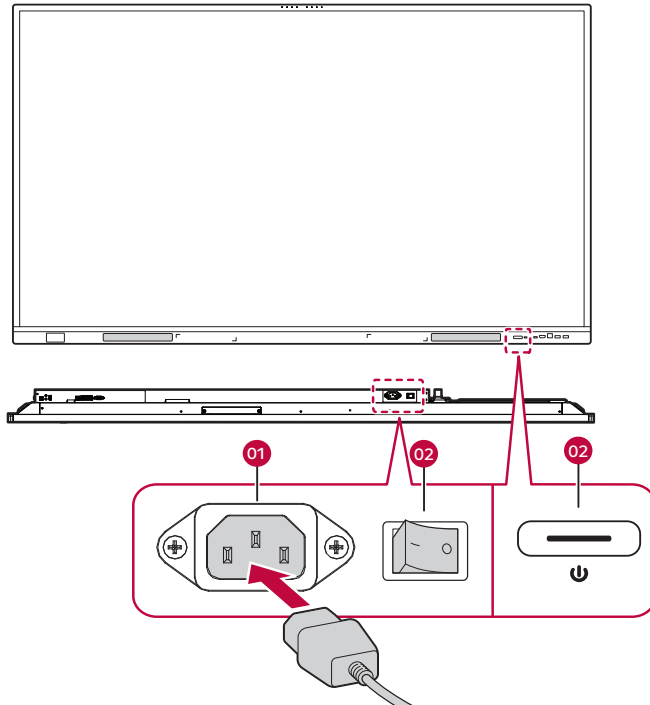

- 1 Connect the power cable provided as a component to the power terminal at the bottom of the product.
- 2 Press the power switch on the front of the product or next to the power terminal to turn the power on.

! Note

- The screen may flicker if the product is turned on when it is cold. This is normal, so there is no need to worry.

No.	Name	Explanation
01	Power Cable Terminal	Connects the power cord.
02	Power switch	Turns the power on or off. - "I" means power on, and "O" means power off.

Exploring the Product

* The illustrations may differ depending on the model.

Names of Each Part

Front

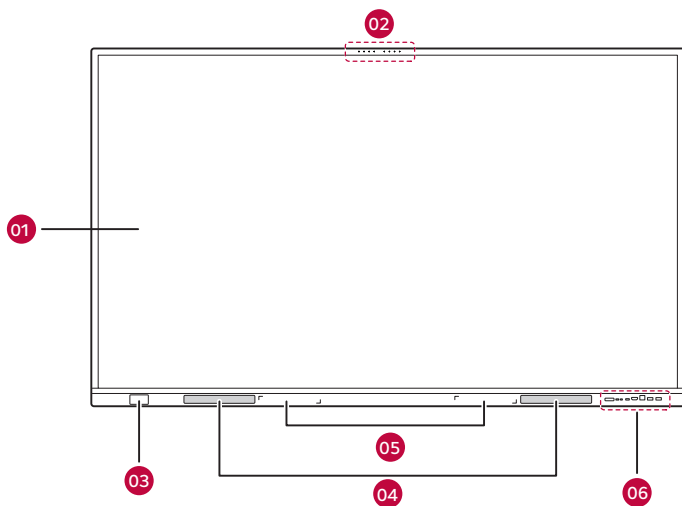

No.	Name	Explanation
01	Touch screen	Screen that displays the contents of the electronic blackboard and can be operated by touching it with your hand or with a touch pen.
02	Microphone	When switched on, the microphone can be used for voice collection.
03	NFC Sensor	Sensor for NFC recognition.
04	Speaker	Outputs the sound.
05	Touch Pen Holder	Holds a touch pen by attaching it magnetically.
06	Front Cable Terminal	Terminals that allow you to connect each of the external devices of the following specifications. <ul style="list-style-type: none">⚡ IN (USB Type-C), HDMI™ 3, TOUCH 3, 3.0 (USB 3.0)

Names of Each Part

Back

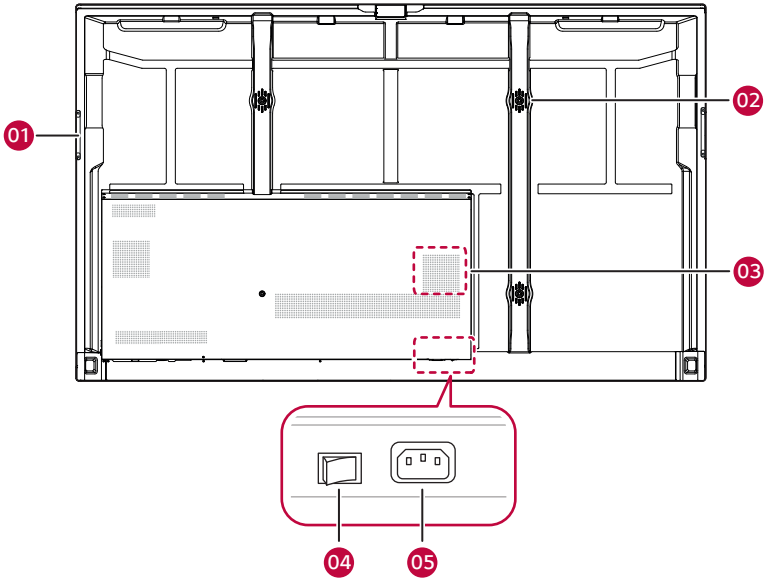

No.	Name	Explanation
01	Handle for Transportation	Used for moving the electronic blackboard. (May vary for different models.)
02	Screw Holes	Used for mounting the electronic blackboard on a stand or installing it on a wall with a wall mount.
03	Bass speaker	Outputs low-pitched sound.
04	Power Sources	Turns the power on or off.
05	Power Cable Terminal	Connects the power cord.

Side

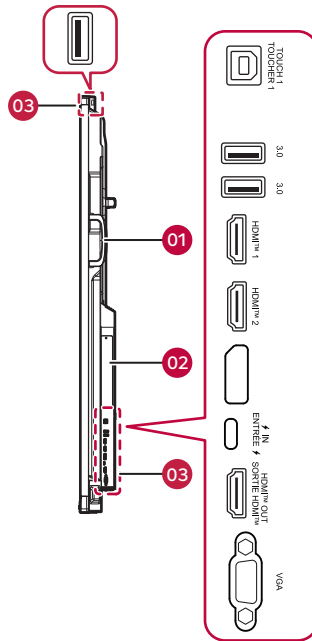

Exploring the Product

No.	Name	Explanation
01	Handle for Transportation	Used for moving the electronic blackboard. (May vary for different models.)
02	Built-in PC (OPS) Slot	Inserts the built-in PC (OPS).
03	Side Cable Terminal	<p>Terminals that allow you to connect each of the external devices of the following specifications.</p> <ul style="list-style-type: none"> TOUCH 1, 3.0 (USB 3.0), HDMI™ 1/2, IN (USB Type-C), HDMI™ OUT, VGA

Checking the Input/Output Terminals

Check the location and function of the input/output terminals for connecting external devices to the electronic blackboard.

Front Cable Terminal

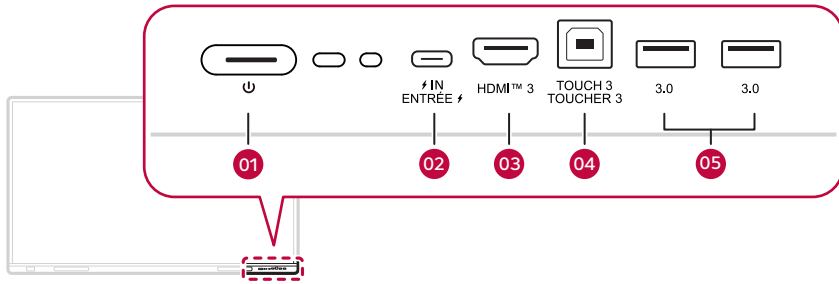

No.	Name	Explanation
01	Power Sources	Turns the power on or off.
02	⚡ IN (USB Type-C)	Used to connect external devices with a USB Type-C cable. Supports charging, data transfer, audio and video output interface expansion, etc.
03	HDMI™ 3	Used to connect external devices with a HDMI cable.
04	TOUCH 3	Used for touch control of the PC screen input through the HDMI 3 terminal. Used to connect the electronic blackboard's TOUCH 3 terminal and PC with a TOUCH cable.
05	3.0 (USB 3.0)	Used for data transfer or connecting USB devices such as a mouse or keyboard with a USB cable.

Side Cable Terminal

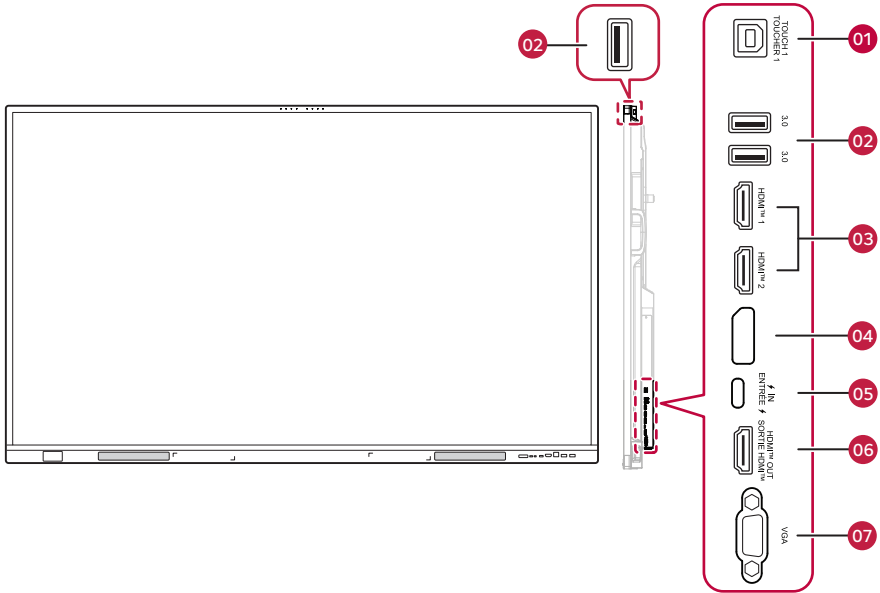

No.	Name	Explanation
01	TOUCH 1	Used for touch control of the PC screen input through the HDMI 1 terminal. Used to connect the TOUCH 1 terminal and PC with a TOUCH cable.
02	3.0 (USB 3.0)	Used for data transfer or connecting USB devices such as a mouse or keyboard with a USB cable.
03	HDMI™ 1/2	Used to connect external devices with a HDMI cable.
04		Used to connect external devices with a DP cable.
05	⚡ IN (USB Type-C)	Used to connect external devices with a USB Type-C cable. Supports charging, data transfer, audio and video output interface expansion, etc.
06	HDMI™ OUT	Used to export the screen to an external device with an HDMI cable.
07	VGA	Used to connect an external device using the VGA cable.

Bottom Cable Terminal

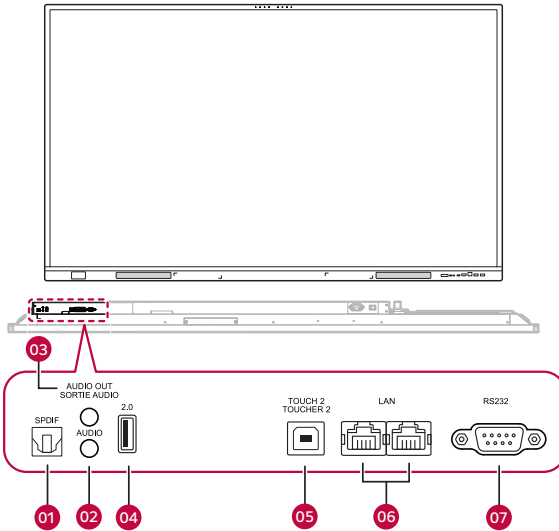

No.	Name	Explanation
01	SPDIF	Used to output audio to an external device using an SPDIF cable.
02	AUDIO	Used to input audio from an external device.
03	AUDIO OUT	Used to output audio to an external device.
04	2.0 (USB 2.0)	Used for data transfer or connecting USB devices such as a mouse or keyboard with a USB cable.
05	TOUCH 2	Used for touch control of the PC screen input through the HDMI 2 terminal. Used to connect the electronic blackboard's TOUCH 2 terminal and PC with a TOUCH cable.
06	LAN	Used for wired internet connection.
07	RS232	Used to connect an RS232 cable.

Using the Touch Pen

The touch pen can be used for various purposes, such as touching the screen to launch menus or to take notes, annotate, and draw on data.

Getting to Know the Touch Pen Functions

Two pens can be used simultaneously to write or draw together. Different colors can be assigned to each pen.

A pen has a 3 mm (0.1 inches) and 7 mm (0.2 inches) tip at each end, allowing you to use two modes separately with one pen.

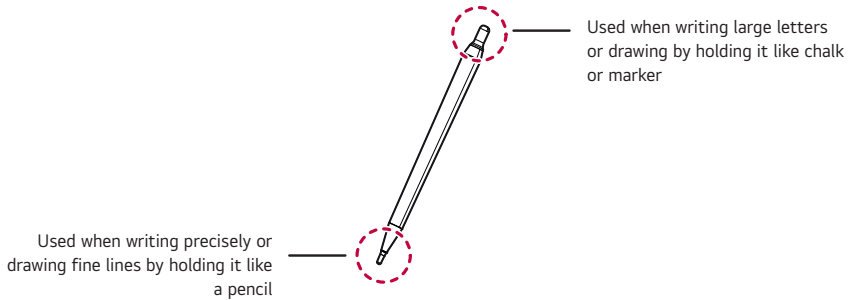

Note

- If you press the pen on the screen for about 2 seconds and release it after you open a built-in PC (OPS), PDF viewer, or Word document, the same pop-up menu as when you right-click on the mouse will appear.

Using the Touch Pen

Storing the Pen

The touch pen can be attached to the magnetic touch pen holder to keep it in place, so you don't lose it.

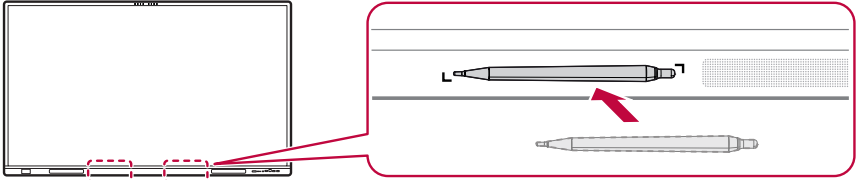

Replacing the Pen Tip

If the touch pen tip is worn or damaged, it must be replaced with a new tip.

- 1 Remove the old tip by pulling on the end with tools such as tweezers.
- 2 Slide the new tip into the pen body.

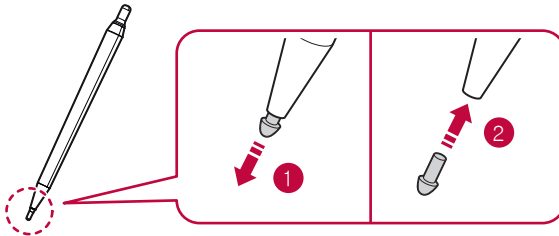

! Note

- To purchase additional touch pens or spare tips, contact LG Electronics.

Using the Wi-Fi Module

Installation Procedure

Caution

- Ensure the power cord of the product is disconnected before installation.

- 1 Unscrew and remove the Wi-Fi module cover located on the bottom of the product.

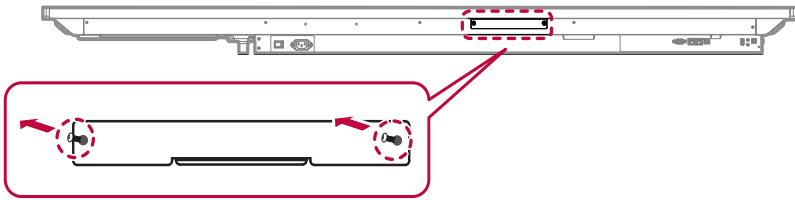

- 2 Following the direction of the arrow, insert the Wi-Fi module fully into the slot.

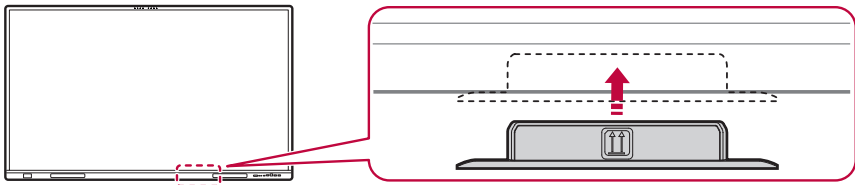

Feature

Once installation is complete, power on the product to automatically activate the Wi-Fi module.

- 1 Click [Settings] on the screen.
- 2 Clicking on [Wireless & Network] allows you to turn on and off [Wi-Fi] and [Hotspot] items.

Precautions for Use

Dust

The warranty will not cover any damage caused by using the product in an excessively dusty environment.

Afterimage

- After-image appears when the product is turned off.
 - Pixels may be damaged rapidly if a still image is displayed on the screen for a long period of time. Use the screen-saver function.
 - Switching from a screen with high differences in luminance (black and white or grey) to a darker screen may cause an afterimage. This is normal due to the display characteristics of this product.
- When the LCD screen is in a still pattern for extended periods of use, a slight voltage difference may occur between the electrodes that operate the liquid crystal (LC). The voltage difference between the electrodes increases over time and tends to keep the liquid crystal aligned in one direction. At this time, the previous image remains, which is called an afterimage.
- Afterimages do not occur when continuously changing images are used but take place when a certain screen is fixed for a long time. The following are operational recommendations for reducing the occurrence of afterimages when using a fixed screen. The maximum recommended time for switching the screen is 12 hours. Shorter cycles are better for preventing afterimages.

Recommended Usage Condition

- 1 Change the background color and text color at equal intervals.
 - Afterimages occur less when the colors to be changed are complementary to one another.

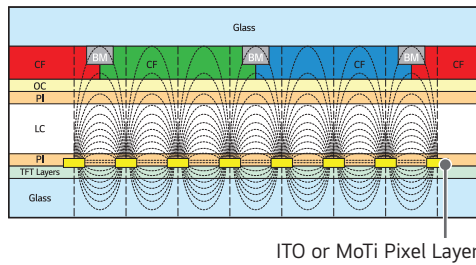

- 2 Switch the screen at equal time intervals.
 - Take caution, and ensure that text or images from before the screen change are not left in the same location after the screen change.



Product Specifications

Without prior notice, all product information and specifications contained in this manual are subject to change to improve the performance of the product.

The ~ symbol means alternating current, and the symbol $\overline{\text{---}}$ means direct current.

Input/Output Ports	⚡ IN, TOUCH 1/2/3, 2.0, 3.0, HDMI™ 1/2/3, HDMI™ OUT, VGA, SPDIF, AUDIO, AUDIO OUT, LAN, RS232, OPS	
Embedded Battery	Not Applied	
Resolution	Recommended Resolution	VGA: 1920 x 1080 @ 60 Hz
	Max Resolution	HDMI1 / HDMI2 / HDMI3: 3840 x 2160 @ 60 Hz - This may not be supported on some OS or graphics card types.
Environmental Conditions	Operating Temperature	0 °C to 40 °C (32 °F to 104 °F)
	Operating Humidity	10 % to 90 % (Condition for preventing condensation)
	Storage Temperature	-20 °C to 60 °C (-4 °F to 140 °F)
	Storage Humidity	10 % to 90 % (Condition for preventing condensation) * Product box packaging storage conditions

Note

- The maximum power rating of the USB Type-C port installed on this product is 65 W. When using this port to charge electronic devices, the charging power of the electronic device should not exceed the power rating of the port. If the charging power of the electronic device exceeds the charging power rating of the port, do not charge it directly using this port.
- Use a certified USB-C cable. (1.8 M (5.9 ft) or less) If you do not do so, the screen may not be displayed or a connection error may occur.
- USB-C ports do not support DPM (Sleep mode).
- Video daisy chain can be configured through HDMI™ OUT, and the input resolution can be supported up to 3840 x 2160 @ 60 Hz.

Touch screen

OS	Windows 10 / Windows 8 / Windows 7 / Android / Linux / macOS (Linux / macOS are supported with the 1 Point touch function.)	50 Points
	Chrome OS	16 Points
	Spacing between touches: at least 25 mm (0.9 inches)	

Speaker

* Applicable only to speaker-supporting models.

Audio	RMS audio output	18 W + 2 x 18 W ($\pm 10\%$)
	Input Sensitivity	0.5 Vrms
	Speaker impedance	Speaker : 6 Ω Woofer : 4 Ω

Specifications by Model

55TR3DQ-B 55TR3DQ-I		
Power	Power Voltage	100-240 V~ 50/60 Hz 3.0 A
Dimensions (Width x Height x Depth) / Weight	1269.1 mm x 783.4 mm x 99.7 mm / 26.65 kg (49.9 inches x 30.8 inches x 3.9 inches/ 58.7 lbs)	

65TR3DQ-B 65TR3DQ-I		
Power	Power Voltage	100-240 V~ 50/60 Hz 3.0 A
Dimensions (Width x Height x Depth) / Weight	1488.4 mm x 907.5 mm x 99.7 mm / 34.75 kg (58.5 inches x 35.7 inches x 3.9 inches/ 76.6 lbs)	

75TR3DQ-B 75TR3DQ-I		
Power	Power Voltage	100-240 V~ 50/60 Hz 4.0 A
Dimensions (Width x Height x Depth) / Weight	1709.4 mm x 1031.1 mm x 99.7 mm / 43.85 kg (67.2 inches x 40.5 inches x 3.9 inches/ 96.6 lbs)	

86TR3DQ-B 86TR3DQ-I		
Power	Power Voltage	100-240 V~ 50/60 Hz 4.5 A
Dimensions (Width x Height x Depth) / Weight	1957 mm x 1170.8 mm x 99.7 mm / 54.1 kg (77 inches x 46 inches x 3.9 inches/ 119.2 lbs)	

Resolution

! Note

- Vertical Frequency: The monitor screen functions by the screen image changing dozens of times every second like a fluorescent lamp.
The vertical frequency or refresh rate is the number of image displays per second. The unit is Hz.
- Horizontal Frequency: The horizontal interval is the time taken to display one horizontal line. When one is divided by the horizontal interval, the number of horizontal lines displayed every second is the horizontal frequency. The unit is kHz.

Resolution	Horizontal Frequency (kHz)	Vertical Frequency (Hz)	HDMI	USB Type-C	DP 1.2	VGA
640 x 480 / 60 Hz	31.469	59.94	0	0	0	0
800 x 600 / 56 Hz	35.156	56.25	0	0	0	0
800 x 600 / 60 Hz	37.879	60.32	0	0	0	0
1024 x 768 / 60 Hz	48.363	60.00	0	0	0	0
1280 x 800 / 60 Hz	49.702	59.81	0	0	0	0
1280 x 1024 / 60 Hz	63.981	60.02	0	0	0	0
1360 x 768 / 60 Hz	47.712	60.02	0	0	0	0
1680 x 1050 / 60 Hz	65.290	59.95	0	0	0	0
1920 x 1080 / 60 Hz	67.500	60.00	0	0	0	0
480p / 60 Hz	31.500	60.00	0	0	0	-
576p / 50 Hz	31.250	50.00	0	0	0	-
720p / 50 Hz	37.500	50.00	0	0	0	-
720p / 60 Hz	60.00	60.00	0	0	0	-
1080p / 23 Hz	26.973	23.98	0	0	0	-
1080p / 24 Hz	27.000	24.00	0	0	0	-
1080p / 25 Hz	28.125	25.00	0	0	0	-
1080p / 29 Hz	33.716	29.97	0	0	0	-
1080p / 30 Hz	33.750	35.00	0	0	0	-

Resolution

Resolution	Horizontal Frequency (kHz)	Vertical Frequency (Hz)	HDMI	USB Type-C	DP 1.2	VGA
1080p / 50 Hz	56.250	50.00	0	0	0	-
1080p / 60 Hz	67.500	60.00	0	0	0	-
720 (1440) x 480i / 60 Hz	15.734	59.94	0	-	-	-
720 (1440) x 576i / 50 Hz	15.625	50.00	0	-	-	-
1080i / 50 Hz	28.125	50.00	0	-	-	-
1080i / 60 Hz	33.750	60.00	0	-	-	-
3840 x 2160 / 24 Hz	54.000	23.98	0	0	0	-
3840 x 2160 / 25 Hz	56.250	25.00	0	0	0	-
3840 x 2160 / 30 Hz	67.500	29.97	0	0	0	-
3840 x 2160 / 50 Hz	112.500	50.00	0	0	0	-
3840 x 2160 / 60 Hz	135.000	59.94	0	0	0	-

Wireless module Specifications

Wireless module (SI07E) Specifications	
Wireless LAN (IEEE 802.11a/b/g/n/ac/ax)	
Frequency range (MHz)	Output power (Max.) (dBm)
2412 to 2472	19.94
5180 to 5320	21.36
5500 to 5700	19.93
5745 to 5825	13.93
5955 to 6415	15.00
Bluetooth	
Frequency range (MHz)	Output power (Max.) (dBm)
2402 to 2480	7.95

- As band channels can vary per country, the user cannot change or adjust the operating frequency. This product is configured for the regional frequency table.
- For consideration of the user, this device should be installed and operated with a minimum distance of 20 cm (7.8 inches) between the device and the body.
- FCC ID : 2AFG6-SI07E / IC : 22166-SI07E

Licence

Supported licenses may differ by model. Visit www.lg.com for more information on licenses.



The terms HDMI, HDMI High-Definition Multimedia Interface, HDMI trade dress and the HDMI Logos are trademarks or registered trademarks of HDMI Licensing Administrator, Inc.



Supplier's Declaration of Conformity

Trade Name	LG
Responsible Party	LG Electronics USA, Inc.
Address	111 Sylvan Avenue, North Building, Englewood Cliffs, NJ 07632
E-mail	lg.environmental@lge.com



This product qualifies for ENERGY STAR®.

Changing the factory default configuration and settings or enabling certain optional features and functionalities may increase energy consumption beyond the limits required for ENERGY STAR® certification.

Refer to ENERGYSTAR.gov for more information on the ENERGY STAR® program.

The model and serial number of the product are located on the back and on one side of the product. Record them below in case you ever need service.

MODEL _____

SERIAL NO. _____

Temporary noise is normal when powering ON or OFF this device.